

modularDIM BASIC
Control module with 3 channels/single, twin push to make switches/
presence detector/modularDIM power supply

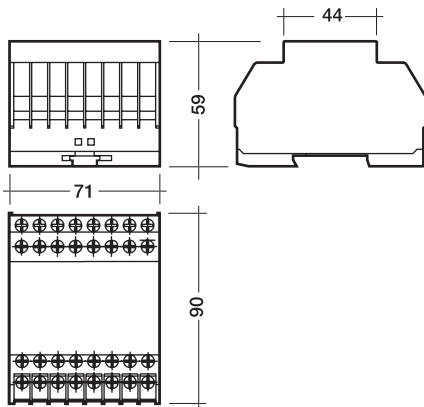

The modularDIM BASIC control module is the basis of the modularDIM product range. The three output channels can be controlled individually or together. Simple installation since no programming is required.

Packaging:
single packaged
box of 10

Parallel connection of several switches enables user-friendly dimming and "ON/OFF" switching from several points. The modularDIM BASIC contains the central power supply for all modularDIM components.

type		modularDIM BASIC	
article number		86454539	
electrical supply	voltage	V	120–277
	frequency	Hz	50/60
	max. load	VA	< 10
input	push to make switches*	–	single/twin
	PIR sensor	–	3
	control line iX (intelligent extension)	–	1
output	digital DSI control signal	–	3
	signal	–	digital/serial
	voltage	V	12 ±10 %
	data rate	Bd	1 200
	max. number of	PCA/TE one4all/PCD	100
	max. cable length	m	250
iX (intelligent extension)	–	1	
temperature	permitted ambient temperature	°C	0 → +50

* Switch inputs are safety low voltage (SELV).
Any standard push to make switch may be used

modularDIM SC
Scene module for independent control of 4 light scenes

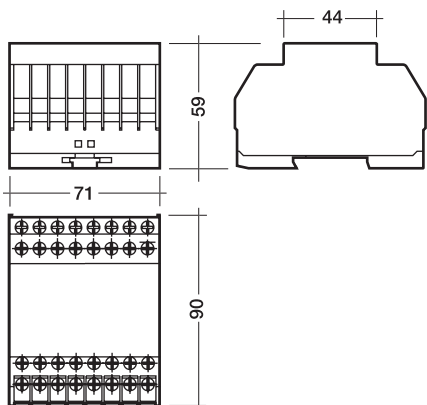

Expansion module for modularDIM systems to control scenes. Enables the recall and programming of four light scenes via the modularDIM BASIC. The switch inputs are SELV and any push to make switches can be used.

Packaging:
single packaged
box of 10

type		modularDIM SC	
article number			86454545
supply	–	–	via iX (intelligent extension)
input	4 push to make switches*	–	single
output	control line iX (intelligent extension)	–	1
	status LED's (8 V)	–	4
temperature	permitted ambient temperature	°C	0 → +50

* Switch inputs are safety low voltage (SELV).
Any standard push to make switch may be used

modularDIM DM
Control with daylight sensor/3 channels

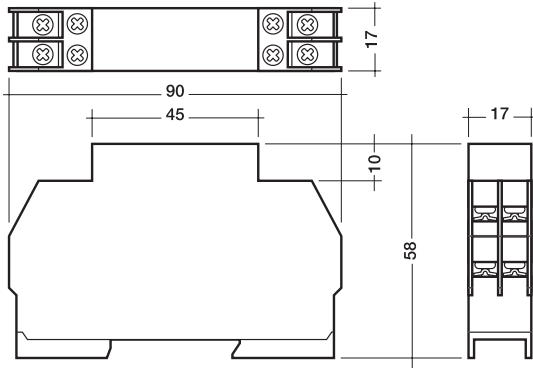

Expansion module for daylight linked control of the modularDIM BASIC module. The daylight information will be passed on from the modularDIM DM to the basic module to control up to three application-specific luminaire groups. Simple programming of each independent luminaire group.

Packaging:
single packaged
box of 10

type			modularDIM DM
article number			86454564
supply	-	-	via iX (intelligent extension)
input	daylight sensor	-	1
	switch manual/automatic	-	1
output	control line iX (intelligent extension)	-	1
temperature	permitted ambient temperature	°C	0 → +50

accessories	sensor DAYLIGHT
article number	86454586

The modularDIM system includes an attractive and solid ceiling mounted sensor for the detection of sky brightness. Its sensing aperture is aligned in the direction of the daylight.

Packaging:
single packaged
box of 10

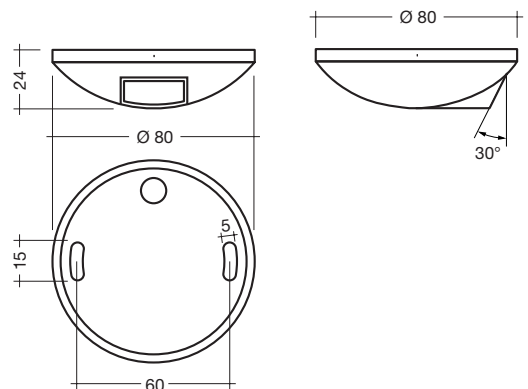

modularDIM LC
“Line Converter” for the integration of mains rated “presence detection” units/sensors

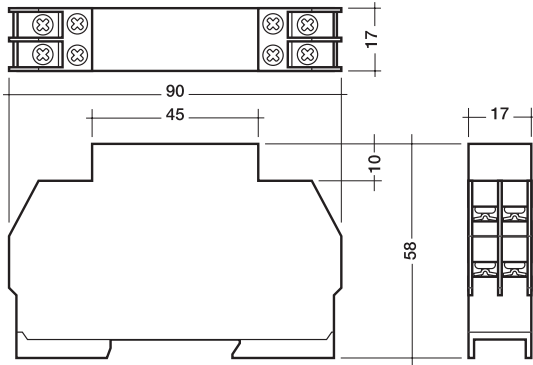

The well known modularDIM system will be extended by the new designed modularDIM LC which provides the opportunity to integrate common, commercial of the shelf mains rated “presence detection (PD) units/sensors” (converts main rated signals into potential free signals based on the galvanic isolation). The modularDIM LC is designed as “to build in unit” for the integration into a switch cabinet. This unit is easy to install

and to commission because there is no programming effort. Therefore this important feature of the modularDIM LC gives now the opportunity to combine the modularDIM system with the common, commercial of the shelf main rated “presence detection (PD) units/sensors”.

Packaging:
single packaged
box of 10

type		modularDIM LC
article number		86457888
voltage	V	220–240
frequency	Hz	50/60
galvanic isolation spec.	–	4000 V 2 min.; 6 mm (SELV)
max. output voltage	V	30
permitted ambient temperature	°C	0 → +50

outputs are safety low voltage (SELV).

Technical description

The modularDIM lighting control system consists of three modules. The modularDIM BASIC module, which acts as a group controller and power supply to the two remaining modules. The modularDIM SC module for recalling light scenes and the modularDIM DM daylight linked module.

modularDIM BASIC

The modularDIM BASIC module is at the heart of the modularDIM concept. It has three output channels which can individually drive up to 100 DSI devices (PCA, TE one4all, PCD) and provides power to the extension modules via the iX interface. DSI devices connected to each channel can be dimmed or switched via the DSI signal as independent channels or combined as one group. In addition the modularDIM BASIC has three PIR inputs to connect standard presence detectors with potential free contacts. Each channel can be switched independently. One presence detector can be linked to all three channels via a bridge to the other PD inputs thereby allowing all three channels to be switched as one.

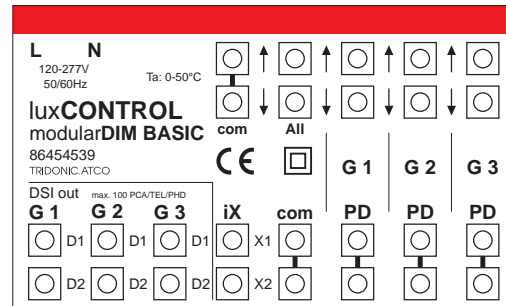

modularDIM SC

The modularDIM SC is an extension module powered directly by the modularDIM BASIC module. It has been designed to allow the user to recall four different light scenes. A short push of the momentary switch recalls a light scene. To store a light scene you must initially set the light levels via the modularDIM BASIC module. A long push (> 10s) to one of the modularDIM SC momentary switches stores the new light scene. Confirmation that the scene has been stored will be indicated by the luminaires connected to the modularDIM BASIC module dimming up and down.

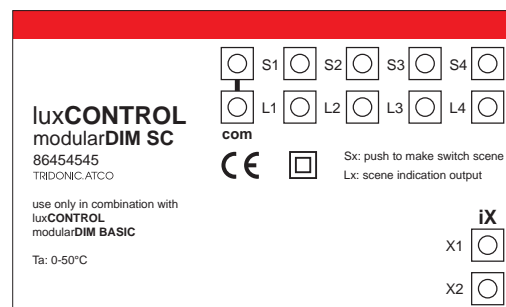

modularDIM LC

The well known modularDIM system will be extended by the new designed modularDIM LC which provides the opportunity to integrate common, commercial of the shelf mains rated "presence detection (PD) units/sensors" (converts main rated signals into potential free signals based on the galvanic isolation). The modularDIM LC is designed as "to build in unit" for the integration into a switch cabinet. This unit is easy to install and to commission because there is no programming effort.

Therefore this important feature of the modularDIM LC gives now the opportunity to combine the modularDIM system with the common, commercial of the shelf main rated "presence detection (PD) units/sensors".

* PD 1 – PD 3 potential free in order to the com-contact (because of the galvanic isolation)



modularDIM DM

The modularDIM DM is an extension module powered directly by the modularDIM BASIC module. It is designed to provide daylight linked control of the artificial lighting in a room. The daylight value if measured by a daylight sensor that is connected directly to the modularDIM DM module. Daylight control is across a dimming range of 0% to 100%, with each channel being programmed with its own dimming characteristic. Channels can be controlled independently or as combinations of channels. The automatic daylight linked control can be disabled via an external switch (switching contact open → daylight function active/switching contact closed → daylight function inactive).

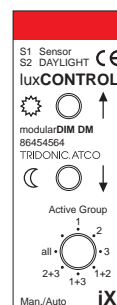

Programming the daylight linked function

The dimming curve for daylight management is set via the modular **DIM DM** module or via the light sensor itself. Two values are stored, appropriate to the external lighting conditions, Twilight and Daylight set points. Two switches on the modular **DIM DM** module represent these positions. Light levels for the programming of the daylight set points are set via the modular **DIM BASIC** module.

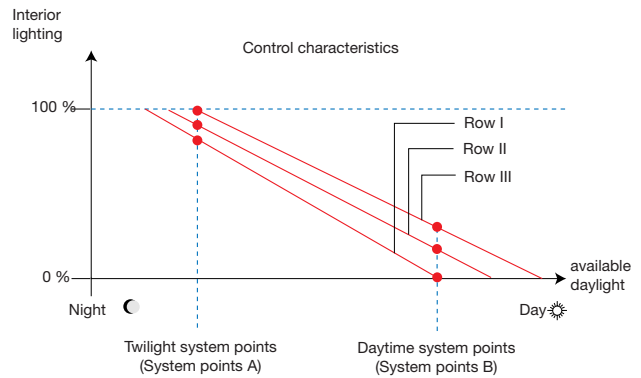

Programming of day time system set point

The settings should be programmed under sufficient daylight conditions, preferably, when the row of luminaires nearest the window, are dimmed to their lowest possible setting to achieve the designed light level.

1. Set desired light level for each row of luminaires I–III via modular **DIM BASIC**.
2. Select respective channels via selector switch on modular **DIM DM** module.
3. Save the daytime system point by pressing (> 5 s) the Sun key (Sys B) by means of e.g. a ball-point.
4. Storage of the system point is acknowledged by the flashing of the lighting source.
5. For programming further channels, repeat steps 1–4.
6. Select the channel you wish to control via daylight management by selecting the appropriate channel or combinations of channels using the selector switch on the modular **DIM DM** module.

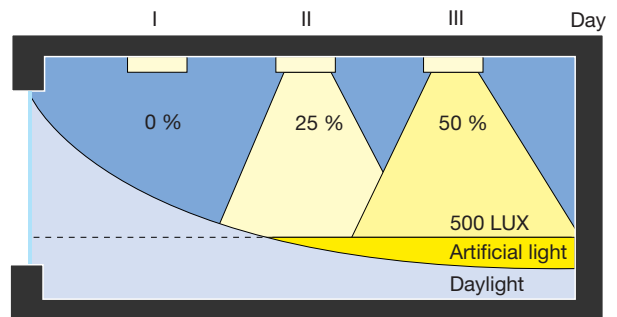

Programming of twilight set points

The settings should be programmed under twilight conditions, preferably, when hardly any daylight is present. Alternatively, the settings may be programmed during the day, with the daylight-sensor covered.

1. Set desired light level for each row of luminaires I–II via modular **DIM BASIC**.
2. Select respective channels via selector switch on modular **DIM DM** module.
3. Save the twilight system point by pressing (> 5 s) the Moon key (Sys A) by means of e.g. a ball-point.
4. Storage of the system point is acknowledged by the flashing of the lighting source.
5. For programming further channels, repeat steps 1–4.
6. Select the channel you wish to control via daylight management by selecting the appropriate channel or combinations of channels using the selector switch on the modular **DIM DM** module.

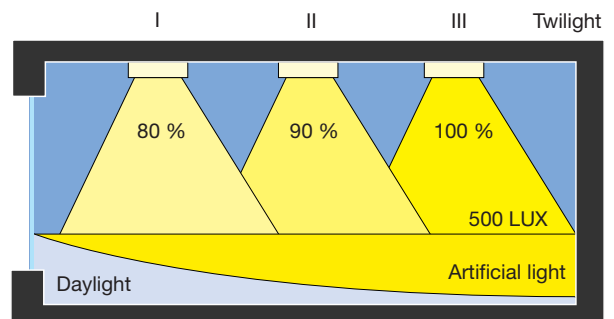

Installation instructions

- To enable several operating points to be used, several keys or switches are connected in parallel.
 - The maximum operating length of all keys, as well as the light sensor, may not be more than a max. length of 100 m.
 - The DSI signal is transmitted by a functional extra low voltage (not safety extra low voltage). Use installation material that is designed for mains voltage installations (230V 50 Hz) therefore.
 - The inputs and outputs for the keys, daylight sensor and for the iX interface meet the requirements for safety low voltage.
- Important note: if one of the safety low voltage inputs/outputs is not wired in accordance with the relevant requirements, the other inputs outputs should also be wired with installation material designed for mains voltage installation (230V 50 Hz).
- The key inputs comply with the requirements of safety low voltages. Any kind of key can be used.

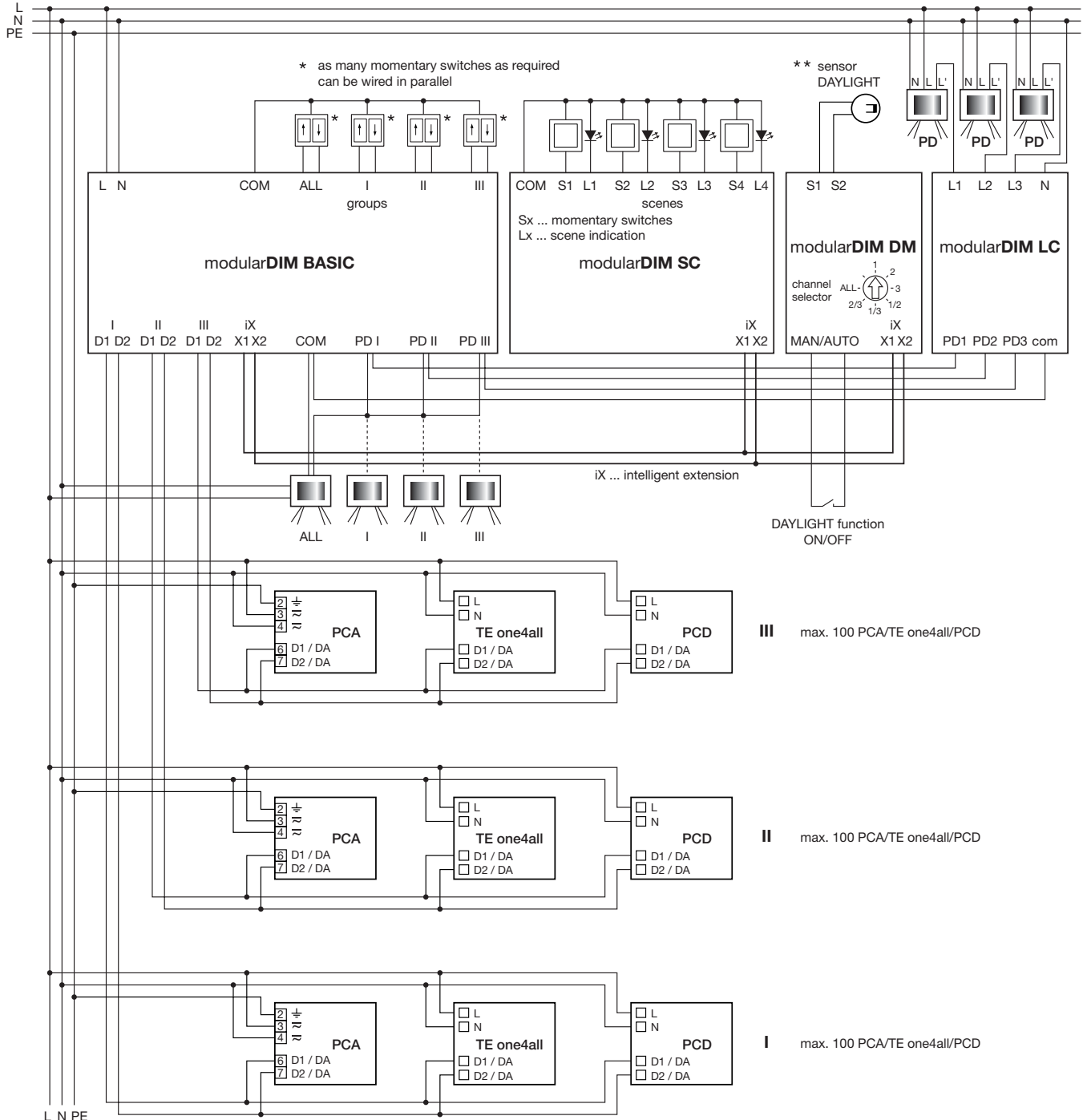

** the light sensor "sensor DAYLIGHT" is to be installed with free view direction window (consider mounting instruction)

maximum wire lengths:

- DSI: max. 250 m
- momentary switch: max. 100 m
- scene indication: max. 100 m
- iX: max. 10 m
- sensor DAYLIGHT: max. 100 m
- DAYLIGHT function ON/OFF: max. 100 m